



轴承型号 1212K+H212

外形尺寸(mm)

d: 60

D: 110

B: 62

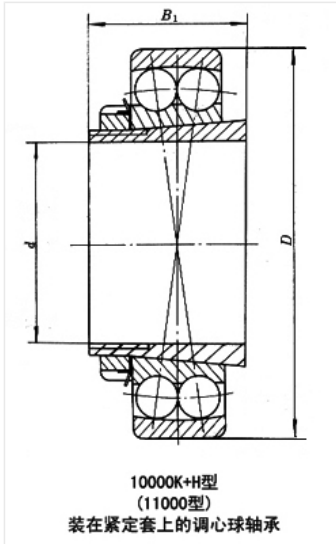

极限转速(rpm)

脂润滑: 5200

油润滑: 6400

额定载荷

Cr(N): 30.2

Cr(N): 11.5

重量(kg) 1.52