



轴承型号 K17X21X15

外形尺寸(mm)

d: 17

D: 21

B: 15

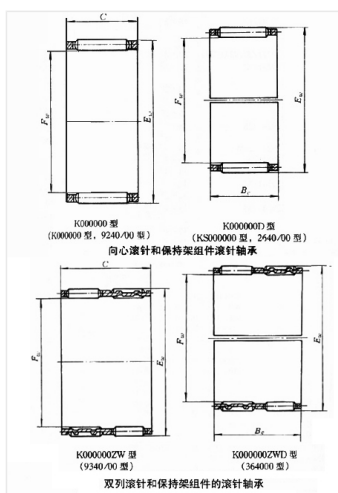

极限转速(rpm)

脂润滑: -

油润滑: -

额定载荷

Cr(N): -

Cr(N): -

重量(kg) -