



轴承型号 K55X61X20

外形尺寸(mm)

d: 55

D: 61

B: 20

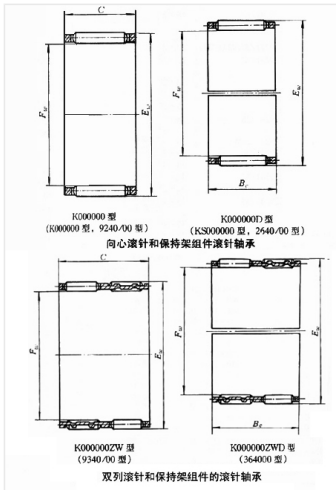

极限转速(rpm)

脂润滑: -

油润滑: -

额定载荷

Cr(N): -

Cr(N): -

重量(kg) -