



轴承型号 K45X50X17

外形尺寸(mm)

d: 45

D: 50

B: 17

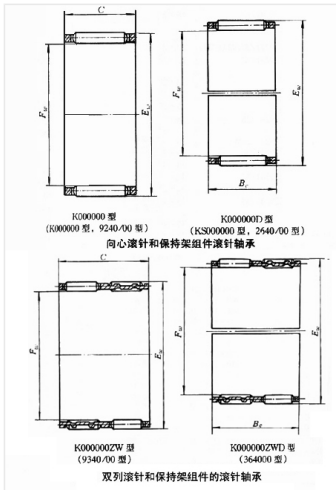

极限转速(rpm)

脂润滑: -

油润滑: -

额定载荷

Cr(N): -

Cr(N): -

重量(kg) -